



CONSTRUCTION LOADALLS

531-70/541-70/535-95/533-105/535-125 HiViz/540-140 HiViz/540-170/540-180 HiViz/540-200

Gross power: 55kW/75hp – 93kW/125hp, Lift capacity: 3000kg – 4000kg, Lift height: 7m – 20m







Unrivalled pedigree...

JCB first pioneered the telehandler concept back in 1977 and have continued to develop the concept to meet the needs of both rental companies and contractors alike. You'll therefore find that these latest Loadalls represent the ultimate in innovation, cost of ownership and corporate responsibility, not to mention: power, productivity, safety, and a whole lot more besides. No wonder then, forty years after developing our first Loadall, JCB remains the world's number one telehandler manufacturer.

NEW to the Loadall range is the 540-180 HiViz which boasts an impressive 4000kg lift capacity and 18m lift height. This new addition to the HiViz range is further evidence of the importance JCB places on site safety – no other manufacturer can compete with the safety and visibility of the JCB HiViz range.

UNRIVALLED PRODUCTIVITY.

THE NEW CONSTRUCTION LOADALL RANGE IS DESIGNED TO MAKE THE MOST EFFICIENT USE OF YOUR TIME AND MONEY. THAT MEANS YOU CAN EXPECT SUPERLATIVE PERFORMANCE, VERSATILITY, VISIBILITY, CYCLE TIMES AND ERGONOMICS. CLASS- LEADING PRODUCTIVITY IS A GIVEN.

A productive machine.

Class-leading JCB hydraulics produce the fastest cycle times, ensuring the most efficient lifting, extending and pushing.

1 The new 540-180 HiViz has a precise high-speed double boom chain extension system to maximise job site efficiency. Electro servo hydraulics and a high-flow 110 l/min hydraulic pump also ensure fast cycle times.

2 The unique regenerative hydraulic system, part of JCB's SMART Technology package, harnesses gravitational forces, diverting oil back to the rams while the arm is lowering. On the 540-180 HiViz and 540-200 this feature helps to reduce cycle times by up to 20% and fuel consumption by 4.4%.

3 A JCB Construction Loadall is extremely manoeuvrable; the compact wheelbase, large steering lock angles and 3 steer modes save valuable time on site.

*Model dependent.



The JCB EcoMAX engine produces its power and torque at low engine speeds, which makes it highly responsive to operate. With a variable geometry turbo for superb performance at low revs, you can expect greater fuel efficiency.*

Multi-function single lever servo control provides fast and accurate load placement and control direction change is easy at the flick of a switch.*

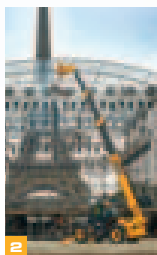
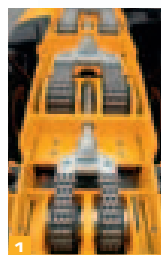



Unrivalled forward reach and lift height along with an industry leading compact design, the JCB Loadall range can take the place of a mobile crane, wheel loader, skid steer or industrial forklift.

UNRIVALLED SAFETY AND SECURITY.

ON-SITE SAFETY IS OF PARAMOUNT IMPORTANCE, SO JCB CONSTRUCTION LOADALLS HAVE A WEALTH OF FEATURES DESIGNED TO PROTECT THEMSELVES, THEIR OPERATORS AND ANY BYSTANDERS. THEY'RE ALSO EQUIPPED WITH A COMPREHENSIVE SECURITY PACKAGE.

Protecting your most important assets.

1 The low boom profile and pivot point provide unrivalled rearward visibility to obstacles and on site traffic. A full set of side and rear-view mirrors enhance all-round visibility and safety compliance.

Secure your Loadall from theft.

LiveLink tracking provides valuable real-time machine location data. Geofencing alerts help to ensure your machine is only used in specified areas.

JCB factory-fit immobilisers can help reduce insurance premiums. The system arms itself automatically after a set period following engine shutdown, and you can choose between key or 4-digit keypad activation.

In many territories, our Loadall security system is Thatcham-approved. The package comprises a JCB LiveLink telematic GPS vehicle tracker, an immobiliser and a Cesar Datatag.

Simple and effective Cesar anti-theft registration comes as standard on all UK Loadalls. The Cesar recognition system is used by police across the UK and Ireland.

A safer choice.

2 A reversing camera and pulse radar options are now available on selected models, the screen is dash mounted and cameras can be mounted to rear and offside for operator peace of mind. For extra safety, we fit a reversing alarm as standard.

3 Sway frames enable an operator to make their machine absolutely level before commencing lifting.

A JCB Construction Loadall has hose burst check valves (HBCVs) to protect the rams from collapse in the event of hose failure.



The cab is Roll Over Protection System (ROPS) and Falling Objects Protection System (FOPS) certified, so operators are safe at all times.

The operator presence switch on Construction Loadalls disables drive when an operator leaves their seat; this prevents accidental operation.

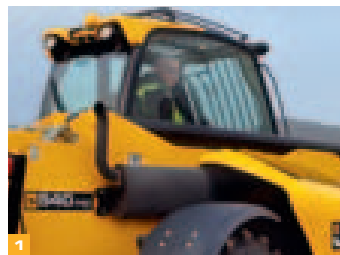



It's not only JCB's revolutionary HiViz range that places the JCB Loadall as one of the safest telehandlers on the market; Our patented load control system and sway frames allows for a safer and more stable load placement, whilst hose burst check valves protects the driver and bystanders in the event of hose failure.

To protect fellow workers on the job site, a new reversing camera and pulse radar options are now available on selected models, the screen is dash mounted and cameras can be mounted to rear and offside for full visibility around the machine.

UNRIVALLED COST OF OWNERSHIP.

A JCB CONSTRUCTION LOADALL ISN'T JUST EFFICIENT TO USE – IT'S HUGELY EFFICIENT TO OWN AND OPERATE TOO. WE'VE DESIGNED THESE MACHINES TO GIVE YOU THE MAXIMUM POSSIBLE RETURN ON YOUR INVESTMENT, WITH GREAT FUEL EFFICIENCY, UNPARALLELED RESALE VALUE AND LOW RUNNING COSTS ALL PART OF THE PACKAGE.

Powering low cost of ownership.

1 Many competitor machines require a DPF to meet Stage IV/Tier 4 Final (T4F) legislation. Instead, a JCB Loadall uses a sealed-for-life SCR system. Among the many benefits of this setup is that there's no loss of productivity during DPF regeneration or replacement costs.

2 The 81kW (109hp) and 93kW (125hp) EcoMAX engines are fitted with a variable speed cooling fan that automatically reacts to ambient temperature, adjusting fan speed for maximum economy and minimum noise.

Using real life fuel consumption data, accessed via our LiveLink Telematics system through 8.5 million customer hours and 10,000 machines, JCB's Loadall range consumed an average of 5.1l/h, which equates to 13.5kg of CO₂ per hour thanks to our efficient high torque EcoMAX engine.

By comparison the 55kW EcoMAX equipped machines consumed 0.64l/h less (1.7kg of CO₂/h) than the 81kW equivalents. This equates to 14.3% less fuel consumption.

Holding its value.

A JCB Construction Loadall is a valuable asset: big global demand, plus legendary productivity, plus super build quality equals maximum resale value.

This, in part, is down to the ability to remap the engine to run on lower-grade fuels, which means your machine (where legislation permits) can be resold across different territories, further boosting residuals.



By producing high levels of power and torque even at engine speeds as low as 1300- 1400rpm, the EcoMAX engine can provide fuel-efficient matching of transmission and hydraulics.





The SMART POWER, 55kW/74hp JCB EcoMAX engine variant will remain free of after-treatment, a DOC and a DPF until 2019. Available across the range, this unique engine greatly reduces maintenance costs and can use up to 14.3% less fuel than the 81kW variant.

The SMART POWER, 55kW engine can't be matched by competitor equivalents. JCB is the only manufacturer to manufacture their entire driveline meaning that all components are configured specifically to get the most out of each model variant.

UNRIVALLED MACHINE UPTIME.

TO MAKE THE MOST OF YOUR INVESTMENT, YOU NEED MACHINERY TO SPEND ITS TIME WORKING, NOT BEING WORKED ON. THAT'S WHY JCB LOADALLS HAVE LONG SERVICE INTERVALS AND, WHEN MAINTENANCE DOES NEED TO BE CARRIED OUT, IT'S EASY AND QUICK TO PERFORM.

Maintaining productivity.

1 Most T4F engines use a Diesel Particulate Filter (DPF). EcoMAX doesn't, so there's no loss of productivity during the regeneration process, nor the extra expense of replacing a DPF.

All daily checks, greasing and serviceable components can be accessed at ground level. Our optional centralised greasing system makes for quicker and easier servicing.*

2 You can access a Construction Loadall's battery easily (and without specialist tools) via a lockable cover that's opened with the ignition key.

3 It's easy to fill both the diesel and AdBlue tanks from ground level. Both tanks also have built-in pre-filters in the filler necks to guard against dirt and contaminants.

A dry lubricant system means a Loadall's wear pads are extremely durable, with 500- hour service intervals.

4 Our construction Loadall range is fitted with a cyclonic air filtration system including an aspirator pre-filtration device to maximise filter life.



1



The filters on a Loadall (engine oil, hydraulic oil and fuel) are centrally located for fast, easy servicing. The air filter double element design simplifies cleaning. Yet another reason why Construction Loadalls have best-in-class SAE serviceability ratings.

4



2



3

* Model Dependent



To prove how good our EcoMAX engines are, we've tested them for 110,000 hours in 70 different machines across the toughest applications and environments.

UNRIVALLED STRENGTH AND DURABILITY.

IN ORDER TO BE TRULY PROFITABLE, CONSTRUCTION LOADALLS ARE DESIGNED TO PROVIDE YOU WITH MAXIMUM UPTIME. OUR MACHINES ARE AS TOUGH AS POSSIBLE, USING TOP QUALITY COMPONENTS AND INNOVATIVE MANUFACTURING PROCESSES. THIS, IN TURN, ENSURES MAXIMUM SERVICE LIFE.

Tried and tested.

1 The new Construction Loadall range's stringent testing programme has included prolonged high stress loading of the chassis, boom and other key components, as well as cold climate testing and repeated transmission use over thousands of cycles.

4 Lift and displacement rams are centralised to ensure load stresses are evenly distributed.

5 The lift, tilt and extension rams are held in place by keyhole castings for greater structural integrity.

Tough boom design.

2 For ultimate strength and durability, there's a large boom overlap of over 1m on every model. Hoses are routed through this boom structure for maximum protection.

Built-in protection.

3 Construction Loadall bonnets are protected from damage by being side-mounted on the chassis and recessed.

Fold-up rear lights can be kept clear and well protected from potential damage on site.

Opt for front and top screen roof guards for added protection from falling objects.

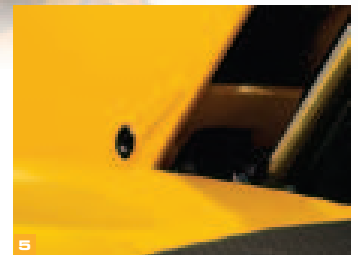
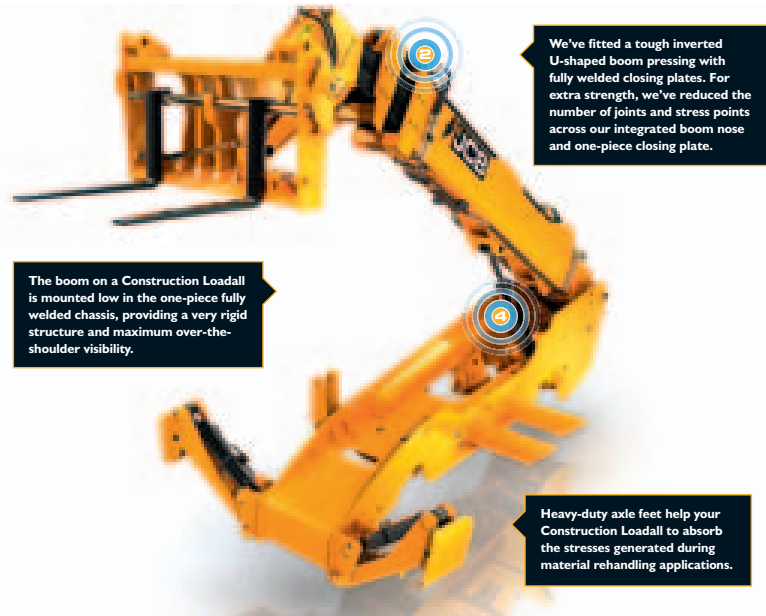

JCB manufactures hydraulic cylinders, cabs, axles, transmissions and engines that are all purpose built for the JCB Loadall range.



UNRIVALLED COMFORT AND EASE OF USE.

FOR A MACHINE TO PROVIDE MAXIMUM EFFICIENCY, IT NEEDS TO BE INTUITIVE AND COMFORTABLE TO OPERATE. WE'VE THEREFORE DESIGNED THE CONSTRUCTION LOADALL RANGE TO PROVIDE THE MOST ERGONOMIC OPERATOR ENVIRONMENT ON THE MARKET SO THAT YOU GET THE MOST OUT OF BOTH MACHINE AND OPERATOR.

Comfortably in control.

1 As standard, the 540-180, 540-140 and 535-125 have simple-to-use twin manual levers with a manual auxiliary. The 540-170 and 540-200 Loadalls are fitted with a servo joystick for fast and precise control (this feature is optional on a 540-180, 540-140 and 535-125).

2 Backlit switches are crystal clear, even in the dark. And new instruments and a Hi-Res TFT screen form an intuitive automotive-style layout.

3 To create the perfect driving position, opt for the easily adjustable tilting telescopic steering column.

4 The 7-speed fan heater creates the most comfortable, productive operator environment.

Visibly better.

Visibility is excellent, courtesy of direct glazing, a large roof screen, standard-fit tinted cab glass and a low mounted boom.

Roof bars are strategically placed for maximum visibility when placing at height. Choose cab, front and rear lights for ultimate visibility.

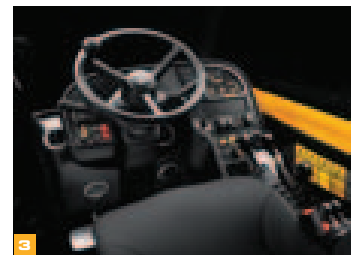

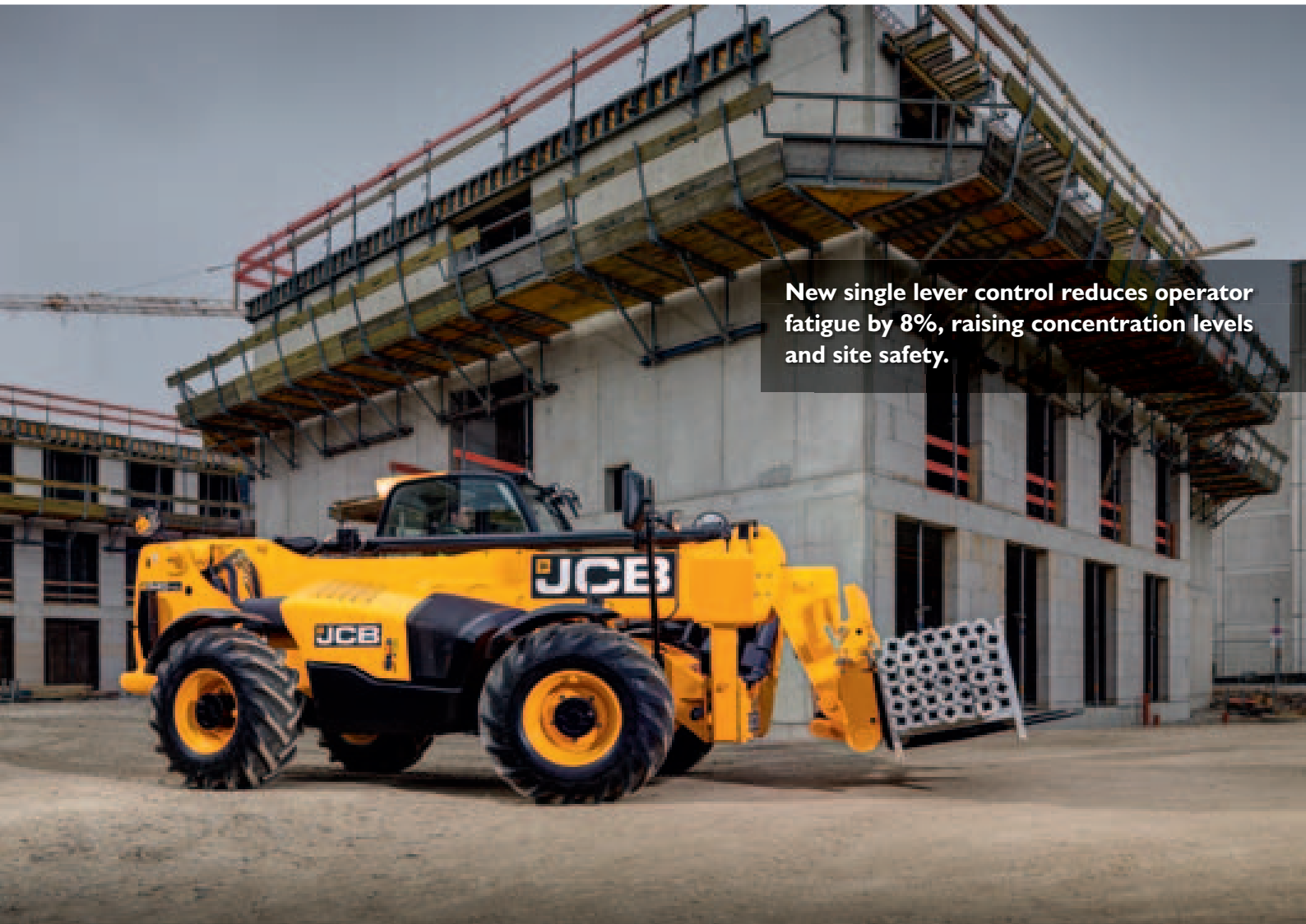

New single lever control reduces operator fatigue by 8%, raising concentration levels and site safety.

THE NEW 540-180 HIVIZ: A SMART INVESTMENT FROM JCB.

INTRODUCING THE NEW 18M 540-180 HIVIZ LOADALL, THIS INDUSTRY LEADING TELESCOPIC HANDLER OFFERS INCREDIBLE RETURN ON INVESTMENT FOR THE RENTAL INDUSTRY, WHILST ENSURING PERFORMANCE AND ONSITE SAFETY IS UNRIVALLED.

A smart investment.

Boasting the industry's lowest cost of ownership, the new 540-180 HiViz is designed to maximise your return on investment throughout its life. Furthermore, JCB's unrivalled residual value means your Loadall is worth more when it's time to replace your machine.

Industry's lowest service maintenance costs.

1 The 540-180 HiViz is designed to spend as much time on site as possible. With the lowest 1000hr servicing costs in the industry, along with ground level daily checks, lead to an industry leading SAE rating.

New on the 540-180 HiViz is the optional centralised greasing system, making daily checks and maintenance even easier.

2 We've also taken into account transportation costs. The small footprint of the 540-180 HiViz means it can be transported in a curtain-sided trailer, whilst tie down points have been designed to ensure securing the Loadall can be completed from ground level.

Work smarter with JCB LiveLink.

3 JCB's own telematics and fleet management system, LiveLink, allows you to keep abreast of your machine fleet. Along with tracking machine hours, LiveLink enables you to monitor fuel consumption, service and maintenance alerts.

LiveLink's real-time geofencing alerts tell you when machines move out of predetermined zones, and real-time curfew alerts inform you of unauthorised usage.

The 55kW/74hp engine variant on the 18m Loadall is free of after-treatment and DEF until 2019. This is achieved by the unique ability to perfectly match all JCB-built components for unbeatable performance with the minimum amount of fuel.

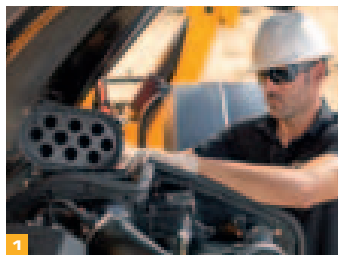

Most Tier 4 Final / Stage IIIb engines use a Diesel Particulate Filter (DPF). EcoMAX doesn't, so there's no loss of productivity during the regeneration process, nor the extra expense of replacing a DPF.



THE NEW 540-180 HIVIZ: WORKING SMARTER.

THERE'S NO MACHINE THAT WORKS HARDER ON SITE – FROM UNLOADING THE FIRST TRUCK TO LIFTING THE LAST ROOF TILE, A TELESCOPIC HANDLER NEVER STOPS. WITH UNIQUE SAFETY FEATURES AND INDUSTRY LEADING PRODUCTIVITY, THE 540-180 HIVIZ CAN DO IT ALL .

Being smart about safety.

1 The HiViz range of JCB Loadalls has long stood for class leading visibility. The 540-180 is the latest in the HiViz range to benefit from the low boom pivot point, enabling unrivalled visibility around the machine.

Sway frames enable an operator to make their machine absolutely level before commencing a lift.

Smart productivity and efficiency.

2 A clever 4-piece boom design combines a hydraulic ram and chains to extend or retract all the sections proportionally in one fast, smooth movement.

JCB's unique regenerative hydraulics harness gravitational forces, diverting oil back to the rams while the arm is lowering. This feature helps to reduce cycle times by up to 20% and fuel consumption by 4.4%.

The JCB EcoMAX engine produces its power and torque at low engine speeds, which makes it highly responsive to operate. With a variable geometry turbo for superb performance at low revs, you can expect greater fuel efficiency.



JCB's patented Adaptive Load Control system, a solution for the Australian standard AS 1418.19, provides smooth progressive boom extension for safe load retention.

2



With a 10% reduced turning circle than the 540-170 as well as 1000kg lighter thanks to a shortened chassis and lightweight boom sections, the 540-180 HiViz is one of the most manoeuvrable machines around.

UNRIVALLED WORK HEIGHT.

JCB AERIAL WORK PLATFORMS ARE AVAILABLE FOR THE 540-200, 540-180, 540-170 AND 540-140 LOADALLS, ALLOWING PERSONNEL TO WORK AT UP TO 20.3M. YOU CAN ALSO CHOOSE FROM TWO PLATFORM TYPES, ENSURING THAT YOU CAN MEET EVEN THE MOST DIFFICULT ACCESS REQUIREMENTS.

A full range of options.

1 By offering our work platforms across three Loadall models, you can be assured of raising personnel to heights up to 20.3m, with a working reach of up to 11.63m.

With two platforms to choose from, you can select your perfect solution:

- > 2.2m fixed, payload 1000kg, 3 persons.
- > 2.4m extending to 4.4m with 180-degree slewing, payload 500kg, 3 persons.

Safe operation.

2 JCB aerial platforms have an interlock on the park brake and stabilisers, with full radio remote control and single key remote activation.

3 There's a built-in motion control system to guard against forward overload; all platform and machine combinations conform to EN280 standards for complete peace of mind.

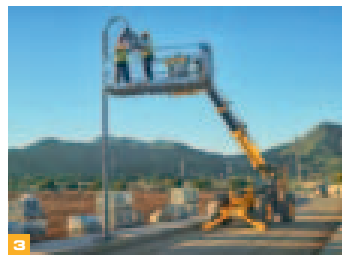



Further widening the versatility of the JCB Loadall, the aerial work platform is more mobile and cost effective than a boom or scissor lift.

UNRIVALLED VERSATILITY THROUGH ATTACHMENTS.

CUSTOMERS CHOOSE JCB CONSTRUCTION LOADALLS BECAUSE THEY'RE LOOKING FOR THE ULTIMATE IN EFFICIENCY, RETURN ON INVESTMENT, SAFETY AND PRODUCTIVITY. ALL JCB LOADALLS HAVE A VERSATILE SINGLE BOOM AUXILIARY FEATURE WHICH CAN POWER MANY ATTACHMENTS. THE JCB QUICKHITCH SYSTEM MAKES ATTACHMENT CHANGING FAST AND EASY.

Concrete skip.

1 A lever-operated discharge gate controls the release of concrete. Fork pockets allow side or rear pick-up and the low profile version is ideal for working within restricted heights.

Integral sideshift.

2 Especially useful when working at height, this feature lets you position forks ready for load pick-up, as well as sideshift a load during placing.

General purpose shovel.

3 This attachment is ideal for efficient re-handling of materials including sand, soil and building waste.

Sweeper collectors.

4 Designed to meet the needs of the modern plant hire company and construction operator, our sweeper collector has a one-piece canopy to take all the knocks of everyday use.

Crane hook.

5 Speed up the process of picking up suspended loads with a crane hook mounted on the forks. This feature makes full use of your versatile Construction Loadall.

Extension jib.

6 It's easy and efficient to handle bulky, suspended loads such as roof trusses, tanks, ducting and prefabricated components with this lightweight strong attachment.

Fork positioner.

7 To reduce operator downtime, manual fork shifting is eliminated by innovative hydraulically controlled fork spacing.



1



2



3

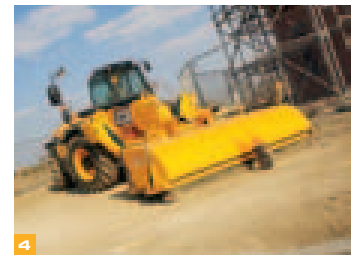

4



5



6



LIVELINK, WORK SMARTER.

LIVELINK IS AN INNOVATIVE SOFTWARE SYSTEM THAT LETS YOU MANAGE JCB MACHINES REMOTELY – ONLINE, BY EMAIL OR BY MOBILE PHONE. ACCESS EVERYTHING FROM MACHINE ALERTS TO FUEL REPORTS AND HISTORY INFORMATION, WITH ALL DATA STORED AT A SECURE CENTRE.

Productivity and cost benefits

By providing information like idle time monitoring and machine fuel consumption, JCB LiveLink helps reduce your fuel usage, saving money and improving productivity. Machine location information can help improve efficiency and perhaps even reduce insurance costs.



Maintenance benefits

Manage machine maintenance easily – accurate hours monitoring and service alerts improve maintenance planning, while real-time location data helps you manage your fleet. Critical machine alerts and maintenance history records are also available.



Security benefits

LiveLink's real-time geofencing alerts tell you when machines move out of predetermined zones, and real-time curfew alerts inform you of unauthorised usage. Further benefits include real-time location information.



VALUE ADDED.

JCB'S WORLDWIDE CUSTOMER SUPPORT IS FIRST CLASS. WHATEVER YOU NEED AND WHEREVER YOU ARE, WE'LL BE AVAILABLE QUICKLY AND EFFICIENTLY TO HELP MAKE SURE YOUR MACHINERY IS PERFORMING TO ITS FULL POTENTIAL.

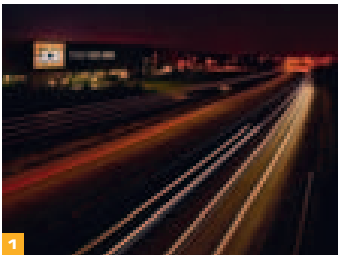

1

1 Our Technical Support Service provides instant access to factory expertise, day or night, while our Finance and Insurance teams are always on hand to provide fast, flexible, competitive quotes.

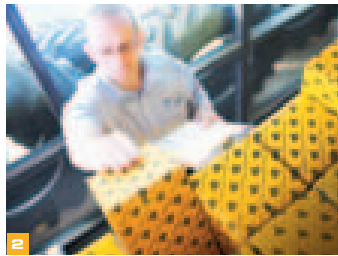

2

2 JCB Assetcare offers comprehensive extended warranties and service agreements, as well as service-only or repair and maintenance contracts. Irrespective of what you opt for, our maintenance teams around the world charge competitive labour rates, and offer non-obligation quotations as well as fast, efficient insurance repair work.

3 The global network of JCB Parts Centres is another model of efficiency; with 16 regional bases, we can deliver around 95% of all parts anywhere in the world within 24 hours. Our genuine JCB parts are designed to work in perfect harmony with your machine for optimum performance and productivity.



3

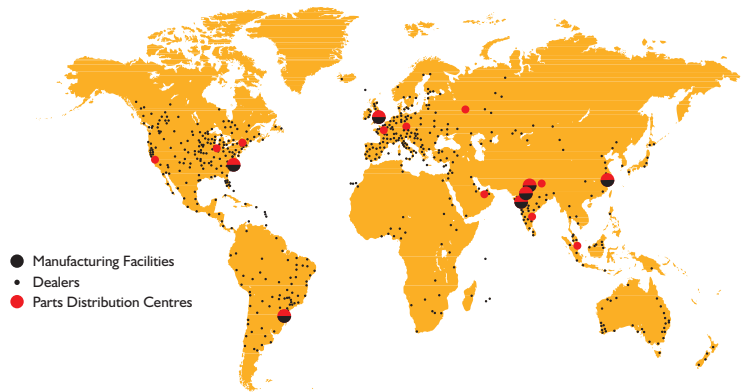

SPECIFICATION

CONSTRUCTION LOADALLS 531-70/541-70/535-95/533-105/535-125 HiViz/540-140 HiViz/540-170/540-180 HiViz/540-200

STATIC DIMENSIONS

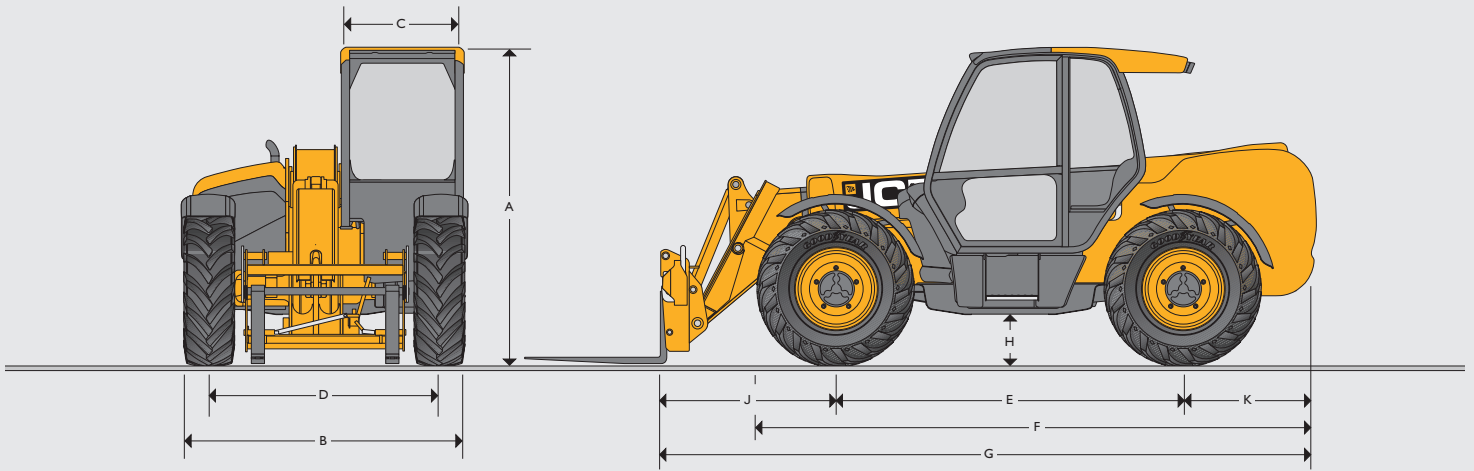

STATIC DIMENSIONS

Machine model		531-70	541-70	535-95	533-105	535-125 HiViz	540-140 HiViz	540-170	540-180 HiViz	540-200
A Overall height	m	2.49	2.49	2.49	2.49	2.59	2.59	2.69	2.59	2.72
B Overall width (over tyres)*	m	2.23	2.23	2.36	2.36	2.35	2.35	2.44	2.35	2.44
C Inside width of cab	m	0.94	0.94	0.94	0.94	0.94	0.94	0.94	0.94	0.94
D Front track	m	1.81	1.81	1.87	1.87	1.90	1.90	1.90	1.90	1.97
E Wheelbase	m	2.75	2.75	2.75	2.75	2.75	2.75	2.75	2.75	2.75
F Overall length to front tyres	m	4.38	4.38	4.38	4.38	4.74	4.74	5.08	4.75	5.09
G Overall length to front carriage	m	4.99	4.99	4.99	5.38	5.80	6.23	6.36	6.27	6.81
H Ground clearance	m	0.40	0.40	0.40	0.40	0.40	0.40	0.40	0.40	0.41
J Front wheel centre to carriage	m	1.25	1.25	1.20	1.62	1.68	2.11	1.94	2.15	2.39
K Rear wheel centre to rear face	m	0.99	0.99	1.04	1.01	1.37	1.37	1.67	1.37	1.67
Overall width with stabilisers fully deployed	m	NA	NA	NA	2.63	2.57	2.57	3.55	3.39	3.82
Outside turn radius (over tyres)	m	3.7	3.7	3.7	3.7	3.75	3.75	4.10	3.75	4.1
Carriage rollback angle	degrees	42.6	42.6	41.0	41.2	37.0	37.0	39	36.50	39
Carriage dump angle	degrees	37.5	37.5	24.0	24.0	12.5	12.5	8.8	12.50	8.8
Weight	kg	7060	7850	8215	8850	10066	10880	12060	11380	12985
Tyres		15.5/80-24	15.5/80-24	15.5/80-24	15.5/80-24	15.5/80-24	15.5/80-24	15.5/80-24	15.5-25	17.5-25

* Type dependent

CONSTRUCTION LOADALLS 531-70/541-70/535-95/533-105/535-125 HiViz/540-140 HiViz/540-170/540-180 HiViz/540-200

SPECIFICATION

LIFT PERFORMANCE

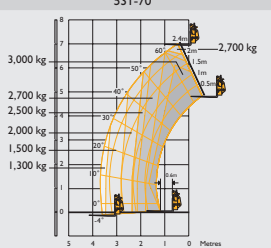
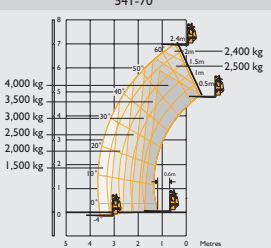
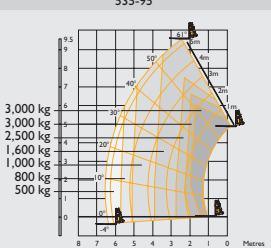
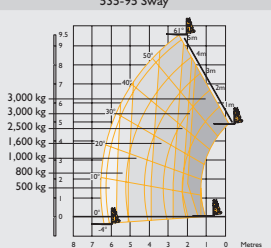
	531-70	541-70	535-95	535-95 Sway
				
Maximum lift capacity	kg 3000	kg 4000	kg 3000	kg 3000
Lift capacity to full height	kg 2700	kg 2400	kg 1600	kg 1600
Lift capacity at full reach	kg 1300	kg 1500	kg 500	kg 500
Lift height	m 7.0	m 7.0	m 9.50	m 9.50
Reach at maximum lift height	m 0.54	m 0.54	m 2.49	m 2.49
Maximum forward reach	m 3.7	m 3.7	m 6.52	m 6.52
Reach with 1 tonne load	m 3.7	m 3.7	m 5.08	m 5.08
Placing height	m 6.3	m 6.3	m 8.78	m 8.78

Complies with stability test EN 1459 Annex B. Chassis Levelling (Sway) with stabilisers retracted (Sway angle $\pm 9^\circ$).

LIFT PERFORMANCE

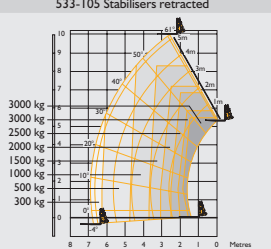
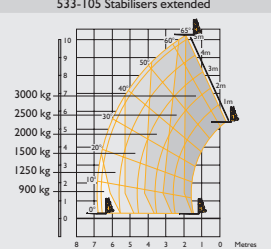
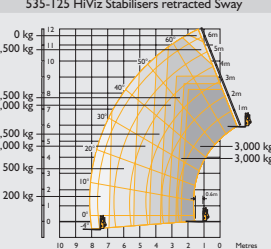
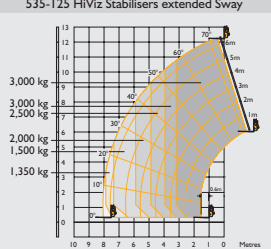
	533-105 Stabilisers retracted	533-105 Stabilisers extended	535-125 HiViz Stabilisers retracted Sway	535-125 HiViz Stabilisers extended Sway
				
Maximum lift capacity	kg 3000	kg 3000	kg 3000	kg 3000
Lift capacity to full height	kg 1000	kg 2500	kg 1500	kg 3500
Lift capacity at full reach	kg 300	kg 900	kg 200	kg 1350
Lift height	m 10.22	m 10.22	m 11.6	m 12.27
Reach at maximum lift height	m 2.69	m 1.99	m 2.01	m 0.54
Maximum forward reach	m 6.83	m 6.83	m 8.06	m 8.06
Reach with 1 tonne load	m 6.83	m 6.83	m 5.31	m 8.06
Placing height	m 9.44	m 9.82	m 11	m 11.75

Complies with stability test EN 1459 Annex B. Chassis Levelling (Sway) with stabilisers retracted (Sway angle $\pm 9^\circ$).

SPECIFICATION

CONSTRUCTION LOADALLS 531-70/541-70/535-95/533-105/535-125 HiViz/540-140 HiViz/540-170/540-180 HiViz/540-200

LIFT PERFORMANCE

	540-140 HiViz Stabilisers retracted Sway	540-140 HiViz Stabilisers extended Sway	540-170 Stabilisers retracted Sway	540-170 Stabilisers extended Sway
Maximum lift capacity	kg 4000	kg 4000	kg 4000	kg 4000
Lift capacity to full height	kg 1300	kg 3100	kg 1300	kg 2200
Lift capacity at full reach	kg 200	kg 900	kg 0	kg 450
Lift height	m 12.89	m 13.78	m 11.57	m 16.7
Reach at maximum lift height	m 3.09	m 1.01	m 4.32	m 1.97
Maximum forward reach	m 9.70	m 9.64	m 9.04	m 12.50
Reach with 1 tonne load	m 6.61	m 9.64	m 5.76	m 11.70
Placing height	m 12.40	m 13.30	m 10.90	m 16.20

Complies with stability test EN 1459 Annex B. Chassis Levelling (Sway) with stabilisers retracted (Sway angle $\pm 9^\circ$).

LIFT PERFORMANCE

	540-180 HiViz Stabilisers retracted Sway	540-180 HiViz Stabilisers extended Sway	540-200 Stabilisers retracted Sway	540-200 Stabilisers extended Sway
Maximum lift capacity	kg 4000	kg 4000	kg 4000	kg 4000
Lift capacity to full height	kg 500	kg 2400	kg 500	kg 1500
Lift capacity at full reach	kg 0	kg 250	kg 0	kg 200
Lift height	m 10.69	m 17.51	m 10.27	m 20
Reach at maximum lift height	m 6.92	m 1.88	m 6.42	m 2.82
Maximum forward reach	m 10.47	m 13.34	m 9.63	m 15.9
Reach with 1 tonne load	m 6.25	m 11.72	m 6.25	m 10.65
Placing height	m 10.0	m 17.0	m 9.1	m 19.1

Complies with stability test EN 1459 Annex B. Chassis Levelling (Sway) with stabilisers retracted (Sway angle $\pm 9^\circ$).

CONSTRUCTION LOADALLS 531-70/541-70/535-95/533-105/535-125 HiViz/540-140 HiViz/540-170/540-180 HiViz/540-200

SPECIFICATION

LIFT PERFORMANCE

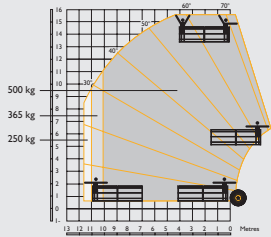
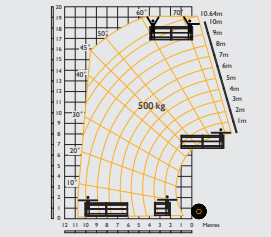
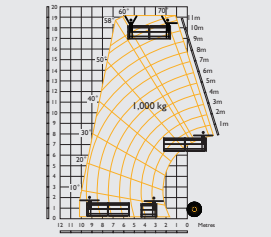
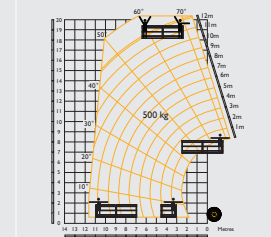
	540-140 HiViz Man platform Stabilisers extended	540-170 HiViz Man platform Stabilisers extended	540-180 HiViz Man platform Stabilisers extended			540-200 HiViz Man platform Stabilisers extended	
							
Machine capacity	kg	4000	4000	4000	4000	4000	
Personnel work height	m	15.6	19.09	19.25	19.25	19.25	20.3
Personnel work reach at maximum reach	m	11.75	11.75	13.16	12.17	10.18	11.63
Platform rated capacity	kg	500	500	365	500	1000	500
Capacity at full reach	kg	365	500 @ 10.78m	365 @ 13.16m	500 @ 12.17m	1000 @ 10.18m	500 @ 11.63m
Maximum forward reach (slewed platform)	m	11.14	10	12.5	11.5	10.18m	11.12
Capacity to full working height	kg	500	500	365	500	1000	500

POINT LOADS

At maximum machine lift capacity (i.e. 4 tonne on a 540-170)

		531-70	541-70	535-95	533-105	535-125 HiViz	540-140 HiViz	540-170	540-180 HiViz	540-200
Load per front wheel	kg	4731	5616	5540	5565	6365	6880	7541	6560	7723
Load per rear wheel	kg	441	480	440	476	415	415	610	1131	730
Load per stabiliser	kg	N/A	N/A	N/A	4188	5151	6010	5824	6243	5760
With no load on the forks and boom retracted in travel position										
Load per front wheel	kg	1803	1847	1957	2312	2499	2484	2694	2608	2992
Load per rear wheel	kg	1819	2200	2273	2078	2530	3060	3457	3462	3462

SPECIFICATION

CONSTRUCTION LOADALLS 531-70/541-70/535-95/533-105/535-125 HiViz/540-140 HiViz/540-170/540-180 HiViz/540-200

ENGINE									
JCB EcoMAX T4 Final, Capacity 4 cylinder 4.4litrs, Aspiration turbocharged cooled									
	531-70	541-70	535-95	533-105	535-125 HiViz	540-140 HiViz	540-170	540-180 HiViz	540-200
Engine 55kW (75hp) @ 2200rpm, 400Nm torque at 1300rpm	Standard	Standard	Standard	Standard	Standard	Standard	Option	Standard	Standard
Engine 81kW (109hp) @ 2200rpm, 512Nm torque at 1300rpm	Option	Option	Option	Option	Option	Option	Standard	N/A	Option
Engine 93kW (125hp) @ 2200rpm, 550Nm torque at 1300rpm	Option	Option	Option	Option	Option	Option	Option	N/A	Option

HYDRAULIC CYCLE TIMES									
	531-70	541-70	535-95	533-105	535-125 HiViz	540-140 HiViz	540-170	540-180 HiViz	540-200
Boom raise s	7.2	8.8	9.1	8.8	10.4	13.5	22.7	13.8	17.3
Boom lower s	5.4	6.5	7.7	8.5	8.1	11	23.4	10.2	15.9
Extend s	6.8	6.8	10.5	13.2	15.7	15.6	18.3	22.4	28.1
Retract s	5	5	11.2	13.6	12.8	14.4	16.7	17.9	22.7
Bucket dump s	3.5	3.5	2.4	2.4	1.8	1.7	4.2	2.9	6.1
Bucket crowd s	2.9	2.9	3.5	3.4	2.3	2.0	4.6	2.6	5.9

HYDRAULICS		
	Hydraulic System Pressure (bar)	Max. Pump flow (litres)
531-70	241	82
541-70	260	82
535-95	241	82
533-105	241	82
535-125	260	110
540-140	260	110
540-170	260	90+72
540-180	260	103
540-200	260	110

NOISE AND VIBRATION					
	55kW	81kW	93kW	Uncertainty	Measurement conditions.
Noise at the operator station LpA	77	80	81	+/- 1 dB	Determined in accordance with the test method defined in EN12053.
Noise emission from the machine LWA	104	106	107	+/- 1 dB	Guaranteed equivalent sound power (external noise) determined in accordance with the dynamic test conditions defined in 2000/14/EC.
Hand-arm vibration m/s ²	<2.5	<2.5	<2.5	N/A	ISO 5349-2:2001 dynamic test conditions.

TRANSMISSION	Torque converter, 4 speed powershift gearbox. Travel speed 531-70/541-70/535-95/533-105: 29kph, 33kph (when 2/4WD select is specified). Travel speed 535-125/540-140/540-170: 29kph. Optional 33kph transmission. Travel speed 540-180/540-200: 29kph.
BRAKING	Service brake: Servo-assisted, hydraulically oil-immersed multi-disc on front and rear axle. Parking brake: Hand operated disc brake on output of gearbox. (93kW/125hp – oil immersed disc type).
CAB	Conforms to ROPS ISO 3471 and FOPS ISO 3449
OPTIONS	Front and rear working lights, rotating flashing beacon, fire extinguisher, traction and industrial tyres, electrical 2/4WD select, limited slip differential in front axle, windscreen and roof guard, air suspension seat, deluxe cab trim, roof and front screen blind, radio kit, air conditioning, reversing fan, deluxe trim, armrest (SLC only), roof moulding. Single lever mechanical joystick, with push button extend and retract. Single lever servo joystick option on 535-125, 540-140 & 540-180. Options of rear or rear & offside reversing cameras with the extra option to add pulse radar all with dash mounted screen. Centralised greasing available on the 540-180 HiViz

All JCB Loadalls comply with Australian standard 1418.19





ONE COMPANY, OVER 300 MACHINES.

Your nearest JCB dealer

Construction Loadalls

531-70/541-70/535-95/533-105/535-125 HiViz/540-140 HiViz/540-170/540-180 HiViz/540-200

Gross power: 55kW/75hp – 93kW/125hp, Lift capacity: 3000kg – 4000kg, Lift height: 7m – 20m

1300 522 232 | jcbcea.com.au

©2009 JCB Sales. All rights reserved. No part of this publication may be reproduced, stored in a retrieval system, or transmitted in any form or by any other means, electronic, mechanical, photocopying or otherwise, without prior permission from JCB Sales. All references in this publication to operating weights, sizes, capacities and other performance measurements are provided for guidance only and may vary dependant upon the exact specification of machine. They should not therefore be relied upon in relation to suitability for a particular application. Guidance and advice should always be sought from your JCB Dealer. JCB reserves the right to change specifications without notice. Illustrations and specifications shown may include optional equipment and accessories. All images are correct at time of print. The JCB logo is a registered trademark of J C Bamford Excavators Ltd.

